

SMN

Model: **D3**

使用说明书 | USER MANUAL

安全注意事项

注意：

为防电击，请勿打开机盖(或后盖)。
本机内部无使用者可以维修的部件。
请委托有资格的技术人员进行维修。



注意
触电危险，
请勿打开。



等边三角形中有箭头闪电标号的图形表示警告使用者在产品内有非绝缘的“危险电压”，可能会对人体造成很大的电击危险。



等边三角形中有感叹号的图形表示警告使用者该设备在操作与维护(维修)方面应严格按照所附设备说明书。



仅适用于海拔2000m以下地区安全使用。

注意：为了完全切断本机的电源，请从墙上插座中拔出插头。电源插头用于完全中断机器的电源供应。

本说明书内容如有更新，恕不另行通知。若您使用的产品功能与说明书不一致时，请以产品为准！

特点

- 每个细节都是High-End级的设计。
- 4片美国BB公司传奇的R-2R芯片PCM1704U-J, 每通道2片,全平衡设计, 最大程度发挥芯片性能!
- 顶级数字滤波芯片SM5847。
- USB使用XMOS第二代16核处理器XU216, 支持到原生DSD512和32位768kHz!
- 时钟系统使用2颗美国ACCUSILICON超低相噪晶振。
- 使用ALTERA的高速CPLD对时钟进行处理,降低JITTER。
- 支持LVDS电平的I2S传输(使用HDMI接口),可以最低JITTER地传输数字音频!
- 内置低时钟抖动VCXO和PLL, 支持接入外部时钟!
- 使用彩色液晶显示屏和新开发的用户界面,全功能遥控。
- 使用7颗美国TI的OPA1612顶级运放。
- 大量使用发烧级元器件,高精度、低温漂和电阻和电容。
- 专门开发的低噪声分立元件电源稳压电路。
- 由英国Noratel制造的定制低噪声灌封环形变压器。
- 全铝合金CNC外壳, 电源和主板分仓设计, 有效隔绝电源干扰。

目录

安全注意事项.....	1
特点.....	2
目录.....	3
技术参数.....	5
关于遥控器.....	6
部件介绍.....	7~8
主机前面.....	7
主机背面.....	8
显示界面和操作介绍.....	9-12
恢复出厂设置/保修条款.....	13

Table of content



Safety notes.....	14
Features.....	15
Specification.....	16
Remote Control.....	17
Functions.....	18-19
Main unit front.....	18
Main unit back.....	19
Operation Instructions.....	20-23
Factory Reset/Warranty Terms.....	24

技术参数

输入方式	USB /光纤/同轴/I ² S/ AES(EBU)		
输出方式	单端线路/平衡线路		
THD+N	0.001%		
动态范围	112dB		
信噪比	112dB		
USB传输方式	异步传输		
USB兼容性	Windows 7 / 8 / 8.1 / 10, Mac OSX, Linux		
位深	USB / I ² S		1bit, 16~32bit
	光纤/同轴/AES(EBU)		1bit, 16~24bit
采样率	USB / I ² S	PCM	44.1~768kHz
		DSD	2.8224~22.5792MHz
	光纤/同轴/AES(EBU)	PCM	44.1~192kHz
消耗功率	10W		
待机功耗	<0.8W		
体积	280X240X51mm(WxHxD)		
重量	3.96kg		

关于遥控器

如果遥控器距离本机很近时操作仍无效，请用新电池更换。

如果要长时间不使用遥控器，请取出遥控器的电池。

按照电池处置的地方性法规处置废旧电池。

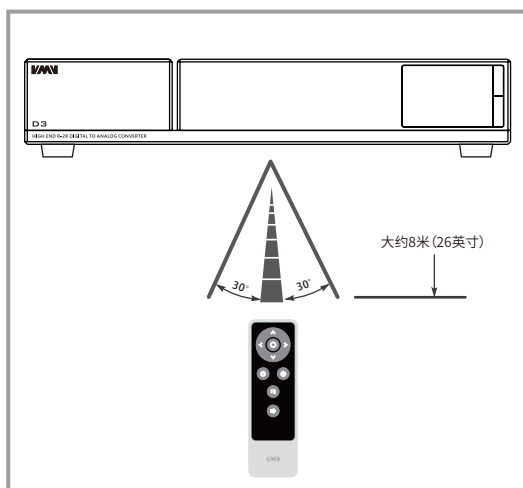
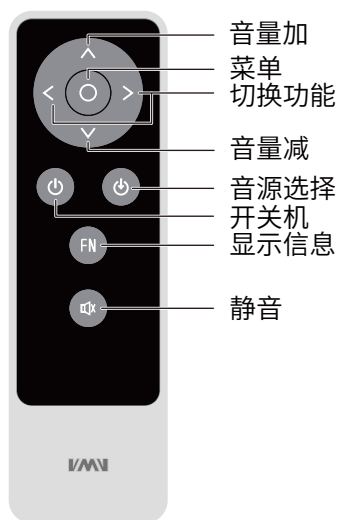

部件介绍

主机前面

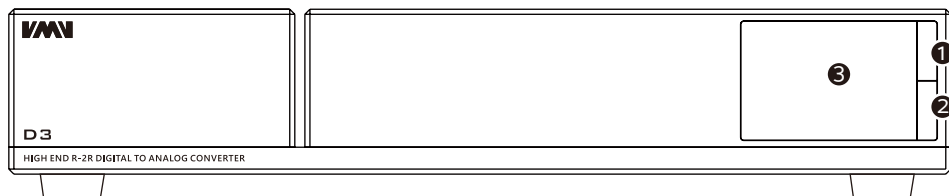

1. 开关机
2. 输入选择按键
3. 显示屏

主机背面

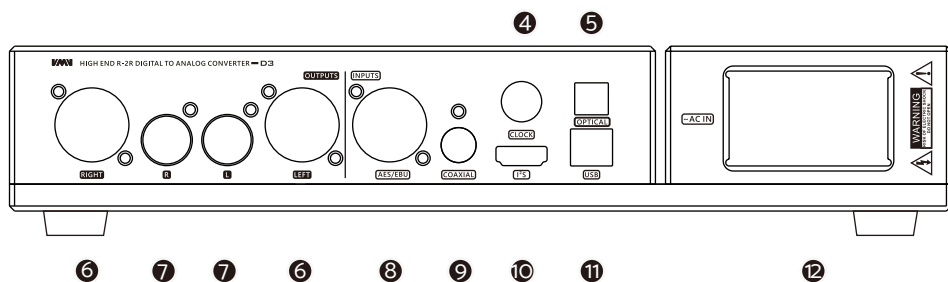

4. 时钟输入

5. 光纤输入

6. 平衡线路输出

7. 单端线路输出

8. AES/EBU

9. 同轴输入

10. I²S接口

11. USB输入

12. 电源输入

显示界面和操作介绍

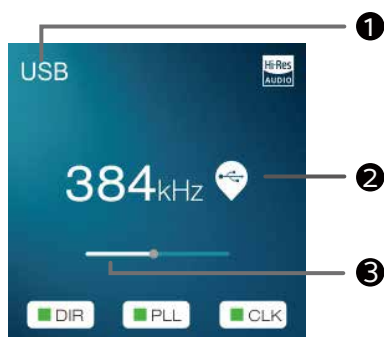

主界面

1. 输入选择
2. 音频显示格式/采样率
3. 音量显示

1. INPUT (输入方式)

- USB AUDIO (USB输入)
- OPTICAL (光纤输入)
- COAXIAL (同轴输入)
- AES/EBU (AES/EBU输入)
- I2S(HDMI) (I²S输入)

2. OS Rate (过采样率)



- OSR4x
- OSR8X

注: 这个设定是设置SM5847是工作在4倍过采样或者是8倍过采样, 听感会稍有区别, 8倍过采样性能较好。

3. CLOCK MODE (时钟模式)

- INTERNAL
(内部时钟)
- DIR SYNC
(同时, 此设置不需要外部输入时钟信号, 除USB输入外, 均有效, 这个设置会使用D3内部的VCXO与外部输入信号的位时钟同步, 可以极大地降低数字音频传输时产生的时钟抖动!)
- EXT 10MHz (USB)
(仅USB使用外部时钟, 此设置需要外部输入10MHz的时钟信号, 仅对USB输入起作用, 其它输入时使用内部时钟, 此时D3使用10MHz的时钟来产生USB播放时需要的时钟, 此设置可以大大提高时钟精确度!)
- EXT 10MHz (ALL)
(都使用外部时钟, 此设置需要外部输入10MHz的时钟信号, 对所有输入起作用, 使用时, 信号源与D3必须同时使用同一个10MHz的时钟源才能同步工作, 否则会引发噪音!)
- EXT WORD
(外部字时钟, 此设置需要外部输入字时钟(频率为44.1kHz)信号, 对所有输入起作用, 使用时, 信号源与D3必须同时使用同一个44.1kHz的时钟源才能同步工作, 否则会引发噪音!)

4. AUDIO PHASE (音频输出相位设置)

- NORMAL (2+,3-) 正常模式(2+, 3-) 
- INVERTED(2-,3+) 反向模式(2-, 3+) 

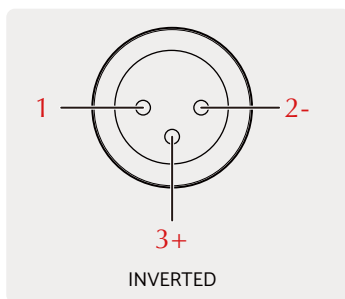
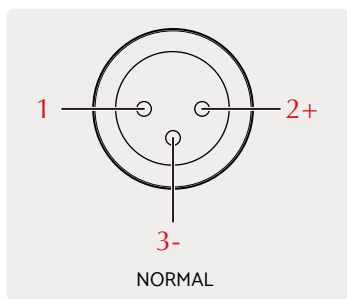

注: 此设置对单端和平衡输出均有效!

5. I²S MODE(I²S相位设置)

- NORMAL 常规相位
- INVERTED 反相

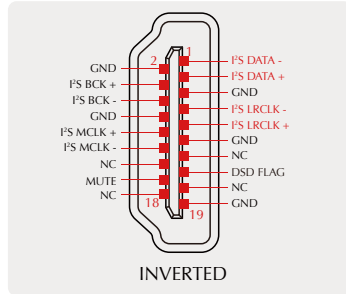
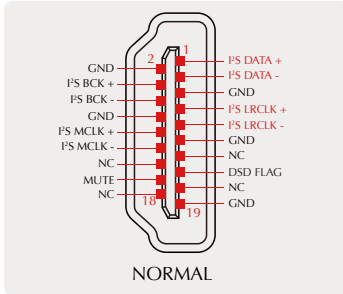

注: 这个选项用于匹配不同的I²S接口标准, 使用前请检查信号源的接口定义。

6. I²S DSD CH(I²S DSD声道设置)

- DSDL=PCM DATA (DSD左声道和PCM的数据引脚共用)(默认)
- DSDL=PCM LRCK (DSD左声道和PCM的LRCK引脚共用)

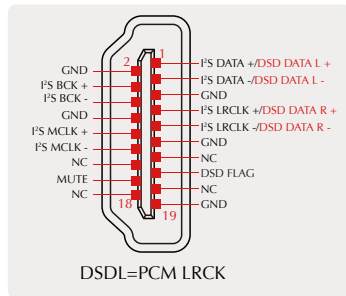
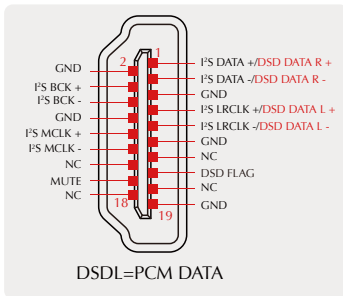

注: 在使用I²S接口播放DSD音频时, 如果发现左右声道不正确, 则可以使用这个选项来纠正。

恢复出厂设置

机器在未通电状态下,按住电源键再通电,直到显示屏显示logo之后,松开按键。

保修条款

一、服务期限

佛山双木三林科技有限公司承诺产品的良好品质,产品自售出之后7天内正常使用情况下出现故障,客户可以选择退货或者保修(不影响二次销售才可退货)。正常使用一年内出现故障可以免费保修。

二、购买日期以销售商开出的购机发票或收据日期为准,网购可以交易截图为准。

三、有以下情况都不能享受“三包”服务

- 一切人为因素损坏,包括非正常工作环境下使用或不按照说明书使用;
- 用户私自拆机、改装、维修;
- 使用非指定或许可的配件造成损坏的;
- 机身的QC或保修贴损毁;
- 不能出示有效购机凭证;
- 不属于本公司产品。

四、保修方式为送修

此条款只适于中国大陆,其它地区请参考当地销售代理商的规定和国家法规。



Safety notes

CAUTION:

TO REDUCE THE RISK OF ELECTRIC SHOCK,
DO NOT REMOVE COVER(OR BACK).



CAUTION
RISK OF ELECTRIC SHOCK
DO NOT OPEN



The lightning flash with arrowhead symbol, with in an equilateral triangle, is intended to alert the user to the presence of uninsulated “dangerous voltage” within the product’s enclosure that may be of sufficient magnitude to constitute a risk of electric shock to persons.



The exclamation point within an equilateral triangle is intended to alert the user to the presence of important operating and maintenance (servicing) instructions in the literature accompanying the appliance.



Safe use only under elevation 2000m.

WARNING:

TO REDUCE THE RISK OF FIRE OR ELECTRIC SHOCK, DO NOT EXPOSE THIS APPLIANCE TO RAIN OR MOISTURE.

The contents of this manual are updated without prior notice. If the function of the product you are using is inconsistent with the instructions, the function of the product shall prevail!

Features

- Every detail is high end design.
- 4 pieces of legendary R-2R chip PCM1704U-J from BB, 2 pieces per channel, fully balanced design, maximize chip performance!
- USB uses XMOS second generation 16 core processor XU216, supports native DSD512 and 32-bit 768kHz!
- Top digital filter chip SM5847.
- The clock system uses two accusilicon ultra-low phase noise crystal oscillators.
- Using Altera's high-speed CPLD to process the clock and reduce jitter.
- Support LVDS level I²S transmission (using HDMI interface), can transmit digital audio with the lowest jitter!
- Built in low clock jitter VCXO and PLL, support access to external clock!
- Full function remote control with color LCD and newly developed user interface.
- Use 7 OPA1612 top OP-AMPs from TI.
- High precision, low temperature drift, resistor and capacitor are widely used.
- Low noise discrete component power supply circuit.
- Customized low-noise sealed toroidal transformer manufactured by Noratel, UK,
- All aluminum alloy CNC shell, separate power supply and motherboard design, effectively isolate power interference.

Specification

Input	USB / Optical / Coaxial / AES(EBU)		
Output	RCA /XLR		
THD+N	0.001%		
Dynamic range	112dB		
SNR	112dB		
USB transmission	Asynchronization		
USB compatibility	Windows 7 / 8 / 8.1 / 10, Mac OSX、 Linux		
Bit depth	USB / I ² S	1bit,	16 ~ 32bit
	Optical / Coaxial/AES(EBU)	1bit,	16 ~ 24bit
Sampling rate	USB / I ² S	PCM	44.1 ~ 768kHz
		DSD	2.8224 ~ 22.5792MHz
	Optical / Coaxial/AES(EBU)	PCM	44.1 ~ 192kHz
Power Consumption	10W		
Standby power	<0.8W		
Size	280X240X51mm (WxHxD)		
Weight	3.96kg		

Remote Control

Install 2 x AAA batteries as instructions

When using the remote control, point it toward the remote control signal receiver on the main unit from a distance of 5 m (16 ft) or less. Do not place obstructions between the main unit and the remote control.

The remote control might not work if the remote control signal receiver on the unit is exposed to direct sunlight or bright light. If this occurs, try moving the unit. Beware that use of this remote control could cause the unintentional operation of other devices that can be controlled by infra.

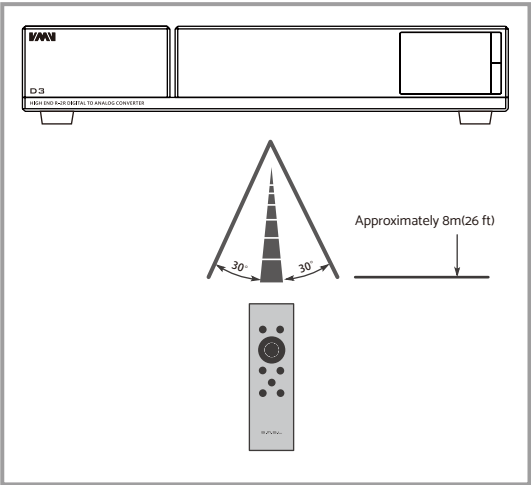
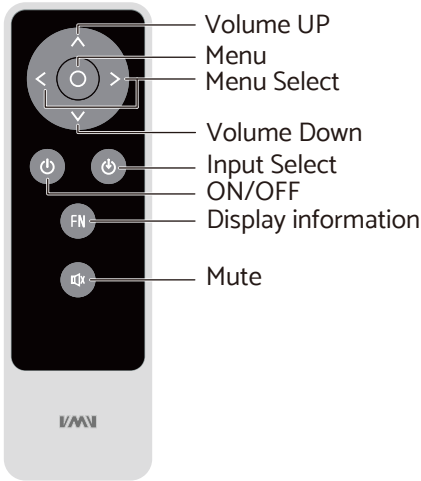

Functions

Main unit front

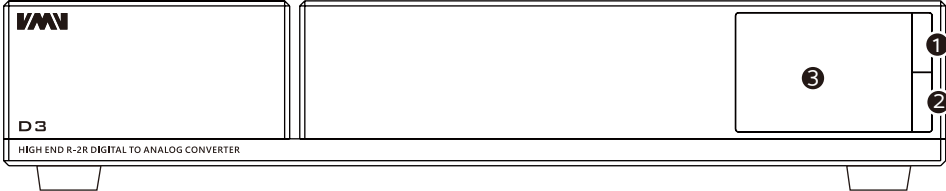

- 1. Turn on/OFF
- 2. Input select knob
- 3. Display

Main unit back

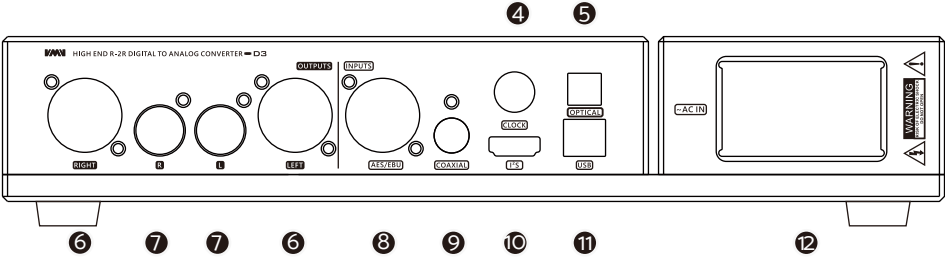

- 4. Clock in
- 5. Optical input
- 6. Balanced output
- 7. Line output
- 8. AES/EBU input
- 9. Coaxial input
- 10. I²S input
- 11. USB input
- 12. Power input

Operation Instructions

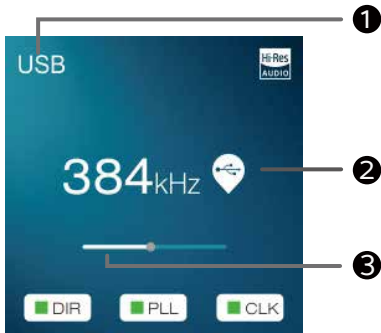

Main Display

1. Input selection
2. Audio format / Sampling rate
3. Volume

1. INPUT

- USB AUDIO
- OPTICAL
- COAXIAL
- AES/EBU
- I²S(HDMI)

2. OS Rate

- OSR4x
- OSR8x

Note: This setting is to set the SM5847 to work at 4 times oversampling or 8 times oversampling, the sound will be slightly different, 8 times oversampling performance is better

3. CLOCK MODE

- INTERNAL

- DIR SYNC

(This setting does not require an external input clock signal, except for the USB input, all are valid. This setting will use the D3 internal VCXO to synchronize with the bit clock of the external input signal, which can greatly reduce the clock jitter generated during digital audio transmission!)

- EXT 10MHz (USB)

(This setting requires an external input 10MHz clock signal, which only works for the USB input. The internal clock is used for other inputs. At this time, D3 uses a 10MHz clock to generate the clock required for USB playback. This setting can greatly improve the clock accuracy!)

- EXT 10MHz (ALL)

(This setting requires an external input of 10MHz clock signal, which works on all inputs. When using, the signal source and D3 must use the same 10MHz clock source at the same time to work synchronously, otherwise it will cause noise!)

- EXT WORD

(This setting requires an external input word clock (frequency 44.1kHz) signal, which works on all inputs. When using, the signal source and D3 must use the same 44.1kHz clock source at the same time to work in synchronization, otherwise it will cause noise!)

4. AUDIO PHASE

- NORMAL (2+,3-) 

- INVERTED(2-,3+) 

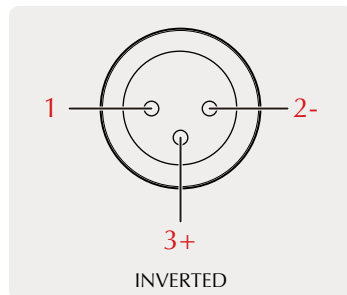
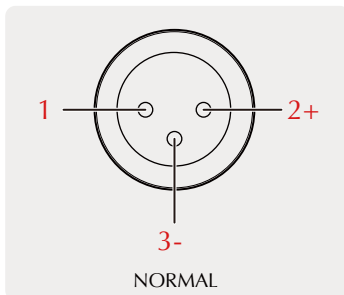

Note: This setting valid for both RCA and XLR output !

5. I²S MODE

- NORMAL
- INVERTED

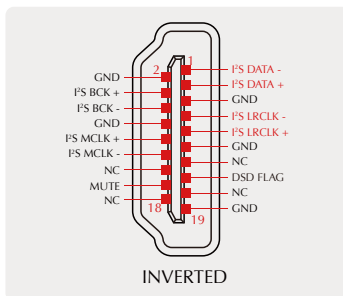
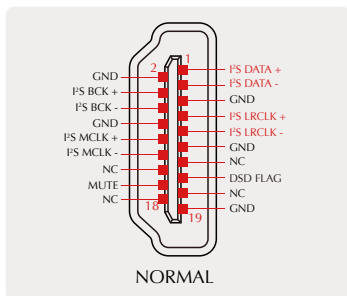

Note: This option is used to match different I²S interface standards, please check the interface definition of the signal source before use

6. I²S DSD CH

- DSDL=PCM DATA (The DSD left channel using the PCM DATA pin)
- DSDL=PCM LRCK (The DSD left channel using the PCM LRCK pin)

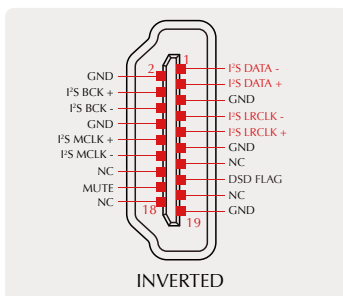
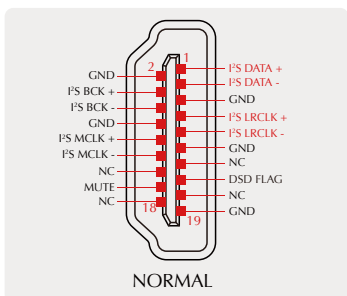

Note: This option is used to match different I²S interface standards, please check the interface definition of the signal source before use

7. I²S DSD FLAG

- DSD FLAG=PIN15
- DSD FLAG=PIN14

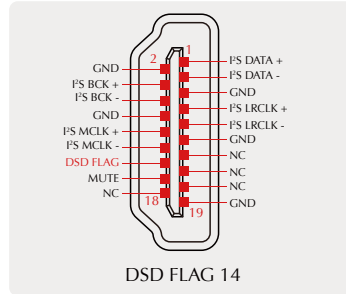
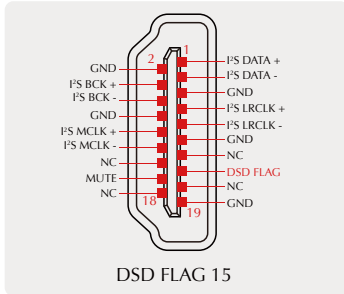

8. DIMMER

- The range is 5 seconds-60 seconds. After setting, the screen will automatically go off within this time, and the screen will re-light up if you operate the remote control or the knob at any time.

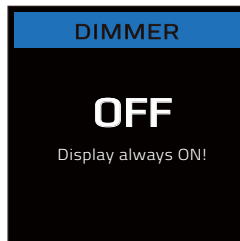

9. BRIGHTNESS

- LEVEL1-6



Factory Reset

Connect the power cord when pressing the power button, until the screen shows logo.

Warranty Terms

1.The Term of Service

Foshan Shuangmusanlin Technology Co., Ltd promises to offer good-quality products. If the product is broken in 7 days after purchasing when you use it normally, you can choose to send it back for return, replacement or repairing (only the product does not affect the second sales can be returned). Repairing for free in one year if you use it normally.

2.Date of purchase is in accordance with the date on invoice or receipt used by seller, and if you buy it on line, you can show the screenshot of trade.

3.If an inappropriate usage causes the unit damaged, the warranty will be void. As below.

- All damages by inappropriate use, including using it under non-normal working environment or without following the instructions.
- Dismantling, refitting, repairing by user in private.
- Causing damage by using some fittings instead of the designative or accredited ones.
- Cannot provide credible proof of purchase.

4.Sending it back to our company for repairing.

5.Contact your S.M.S.L Audio reseller for a return or replacement.